



**TELTONIKA**  
**GSM Desktop Phone**  
**DPH200**

**User Manual v1.02**

## LEGAL NOTICE

Copyright © 2008 TELTONIKA Ltd. All rights reserved. Reproduction, transfer, distribution or storage of part or all of the contents in this document in any form without the prior written permission of TELTONIKA Ltd is prohibited.

**Other product and company names mentioned herein may be trademarks or trade names of their respective owners.**

## ATTENTION



Before using the device we strongly recommend to read this user manual.



Do not rip the device. Do not touch the device if the device is broken or its connecting wires are without isolation.



All wireless devices for data transferring may be susceptible to interference, which could affect performance.



The device is not water-resistant. Keep it dry.



The device requires high 230V AC voltage.

## IMPORTANT NOTES!

**It is mandatory to read the notes and manual carefully before starting to use the device.**

## Table of contents

1	SAFETY INFORMATION .....	4
2	GETTING STARTED .....	5
3	PHONE OVERVIEW.....	8
3.1	Description of the phone.....	8
3.2	LCD screen icons .....	8
3.3	DPH200 menu structure .....	9
4	CALL FUNCTIONS .....	10
4.1	Making calls .....	10
4.2	Receiving calls.....	10
4.3	Ending calls .....	10
5	SMS.....	11
5.1	Read SMS.....	11
5.2	Send SMS.....	11
5.3	Delete SMS.....	11
5.4	Message Settings .....	12
6	ADDITIONAL FEATURES .....	12
6.1	Date and Time Settings.....	12
6.2	Address Book .....	13
6.3	Speed Dialing .....	14
6.4	Audio Settings.....	14
6.5	Alarm .....	15
6.6	Language Selection.....	16
6.7	Dial delay .....	16
6.8	Baby call.....	16
6.9	Security settings.....	16
6.10	Restore Factory Defaults .....	17
7	SUPPLEMENTARY SERVICES (NETWORK DEPENDENT).....	17
7.1	Call Forwarding.....	17
7.2	Call Barring.....	18
7.3	Call Waiting.....	18
7.4	Call Transfer .....	19
8	TECHNICAL SPECIFICATIONS.....	20
9	TROUBLESHOOTING .....	21

## 1 SAFETY INFORMATION

In this document you will be instructed how to use GSM Desktop Phone safely. We suggest you to adhere to following recommendations to avoid any damage to person or property. You have to be familiar with the safety requirements before starting to use the device!



Device requires power supply source that satisfies all safety requirements listed in LST EN 60950-1 standard. Each power supply source should not exceed 15VA.



Socket RJ45 is used for device firmware upgrade. Only qualified personnel with proper equipment can upgrade the device.



Do not mount or serve device during a thunderbolt.

To disconnect power for the device please do the following:

- Plug off AC/DC power adapter from the wall outlet.
- Turn off using power on/off button.

To avoid mechanical damage of the device it is recommended to transport the device packed in damage-proof pack. Protection against over currents, short circuits and earth faults should be provided as a part of the building installation. Additional two pole protective device is required to protect from short-circuit and earth fault. The power of connected device should satisfy power of release device. The creepage distance between contacts should be no less than 3mm. While using the device, it should be placed so, that it would be possible to plug off AC/DC power adapter from the wall outlet.

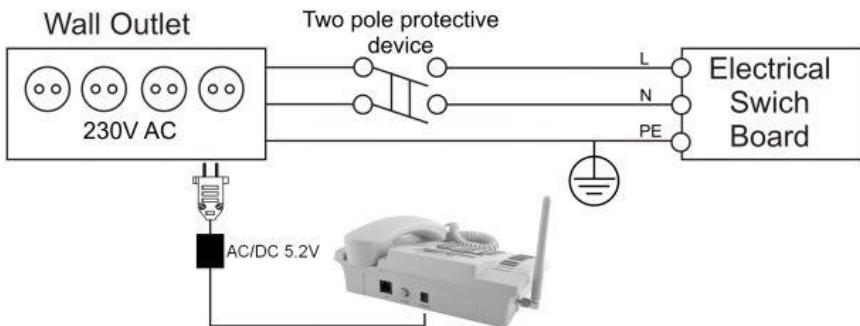

Signal level of the device depends on the environment in which it is working. If the device starts working insufficiently only qualified personnel may repair this product. We recommend to send it to repair centre or to manufacturers. There are no exchangeable parts inside of the device.

## 2 GETTING STARTED

### Package Contents

- A. Handset with cable
- B. Phone device
- C. Battery
- D. Power supply adapter
- E. External GSM Antenna
- F. User manual



Note: If any of the components are missing or damaged, please contact the retailer or reseller from which this product was purchased.

### Inserting SIM card

Note: SIM card is mandatory for setting up connection to the GSM network. If you don't have a SIM card please contact your network service provider.

1. Unplug the power supply adapter
2. Open cover



3. Flip SIM card holder and gently insert SIM card in the slot



4. Close SIM card holder

## Connect back up battery

Battery is under the same cover as the SIM card. To install the battery plug the battery connector in to the battery socket.

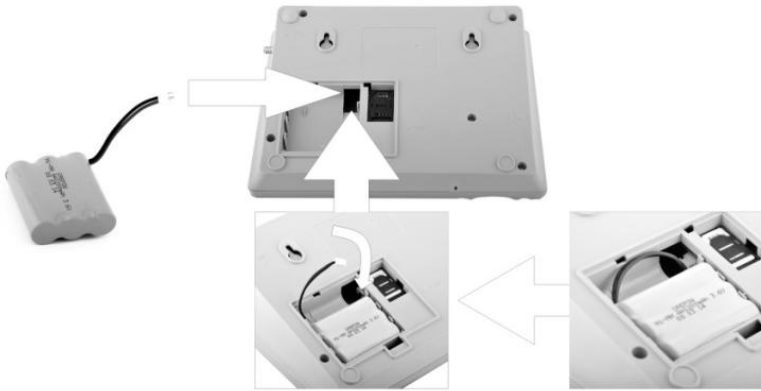

## Connect handset

Connect one handset cable end to the handset and another one to the phone jack.



## Attach antenna

Screw the antenna in a clockwise direction.



Position the antenna upwards at its connecting joint. This will ensure optimal reception.

## Wall mounting

GSM desktop phone can be mounted on the wall. Device has two holes for mounting as shown in figure below:

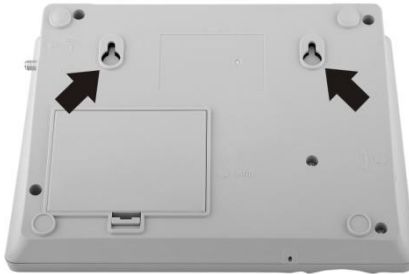

To mount device on the wall please do the following:

1. Mark a location for two holes 115mm horizontally apart and drill two holes in the wall.
2. Install the screws (not supplied) into the wall, leaving a gap of approximately 3 mm between screw head and wall.
3. Mount the GSM desktop phone on screws.

## Turning on GSM desktop phone

Before turning on the phone make sure that:

- SIM card is inserted
- Battery is connected (not necessary)
- Antenna is attached
- Handset is connected to the phone
- Power adapter is connected

After all these operations are done you can switch the phone on by pushing the power button on a back panel. After the device is switched on it will start up. LCD screen will display information that the phone is starting up. To turn off the phone press the same button again.

## 3 PHONE OVERVIEW

### 3.1 Description of the phone

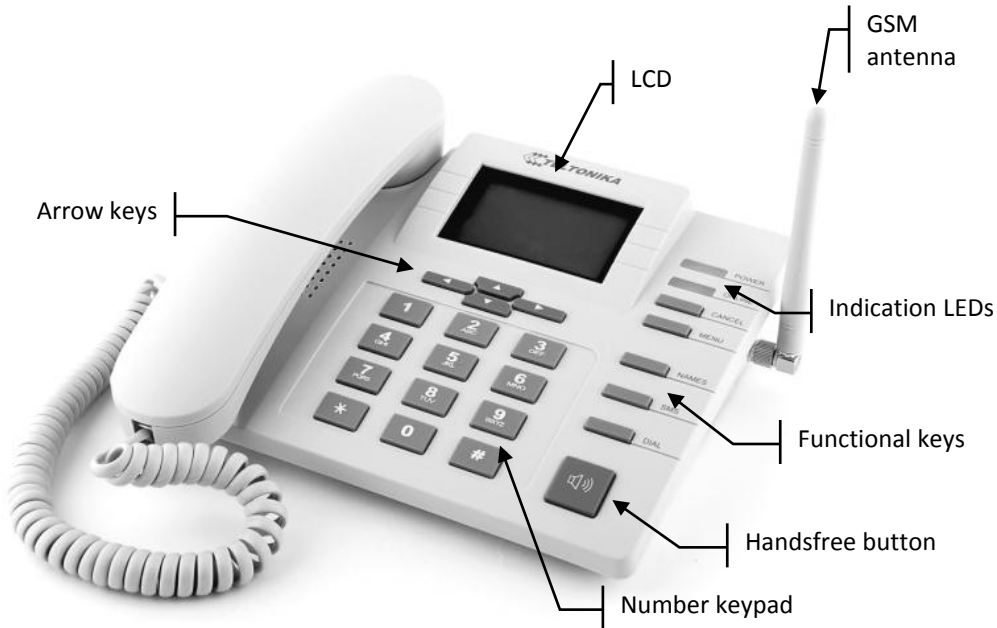

### 3.2 LCD screen icons

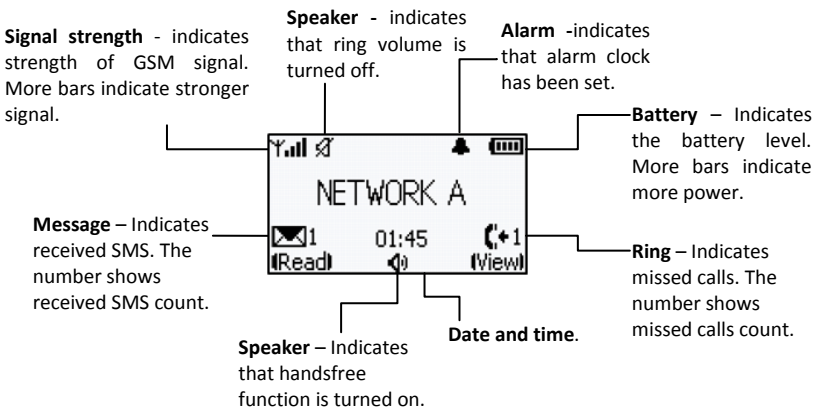



### 3.3 DPH200 menu structure

User friendly menu navigation allows reaching all GSM Desktop phone features.

#### Menu navigation

To enter menu press the functional **Menu** key.

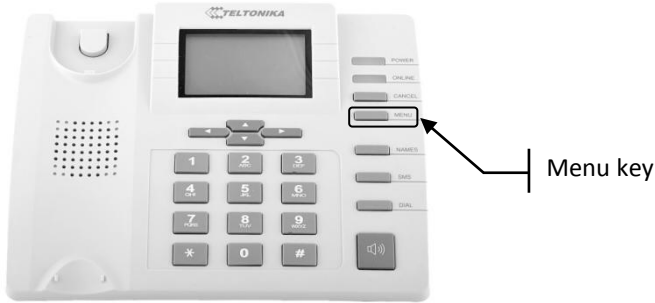

Menu items are selected by using up and down arrow keys ▲ ▼ located below the LCD screen.

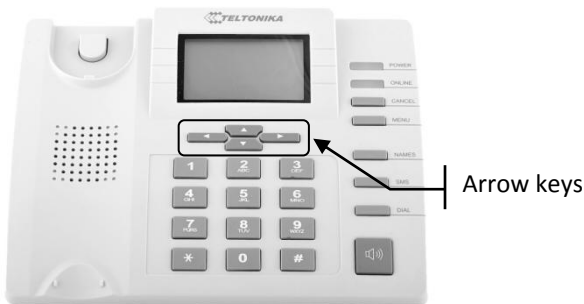

To enter selected menu function press left arrow key ◀ (LCD displays **OK**), to exit press right arrow key ▶ (LCD displays **Exit**).

#### Menu structure is shown below

##### Messages:

Create message  
Inbox  
Clear inbox  
Message settings

##### Call register:

Missed calls  
Received calls  
Dialed numbers  
Clear lists

##### Contacts:

Phone book  
Speed dial  
New contact

##### Settings:

Language  
Sound  
Call services  
Time and date  
Security  
Misc  
Factory reset

## 4 CALL FUNCTIONS

### 4.1 Making calls

- Pick up the handset or press the speaker phone key
- Wait for dial tone
- Enter the phone number then press **DIAL** key or wait for 5s or use a **Phone book** to select contact and press **Call**.

*Note: To input the “+” character press and hold “0” key.*

#### Correct entered number

- To delete one character press the **Delete** key once
- To delete all character press the **Delete** key until all digits are cleared

#### Redial last entered number

- Press the **Dial** key
- Use arrow keys ▲ ▼ to select a number
- Pick up the handset

### 4.2 Receiving calls

#### Answering call

To answer the call, pick up the handset or press the speaker phone key

#### Reject call

To reject call press **Disconn.**

*Note: incoming call number is displayed on the LCD. The caller ID and call number is displayed on the LCD if the number is stored in the phone book.*

*Note: If there are missed calls the icon “Ring” on the LCD screen is displayed. Number near the icon shows how many calls where missed.*

### 4.3 Ending calls

To end a call place the handset back onto the cradle or press the speakerphone key if using the handsfree feature.

## 5 SMS

GSM Desktop phone allows sending and receiving SMS text messages. Each SMS message can be maximum of 160 characters length. Contact your service provider to activate SMS.

### 5.1 Read SMS

#### Read received message

When a new message is received icon “Message” on the LCD screen is displayed. To read the message press **Read**.

#### Read message from inbox

- Press the **MENU** key
- Select **Messages** and press **OK**
- Select **Inbox** and press **OK**
- Select message from the list by using arrow keys ▲ ▼ and press **Read**

#### Reply to received Messages

- View the desired message
- Press **Options** and press **OK**
- Select **Reply** and press **OK**
- Type the text using number keypad and press **Send**
- Press **Send** again

#### Forward text Message

- View the desired message
- Press **Options** and press **OK**
- Select **Forward** and press **OK**
- Enter the phone number or use **Phone book** to select an contact
- Press **Send**

### 5.2 Send SMS

- Press **SMS** key
- Type the text using number keypad and press **Send**
- Enter the phone number or use a **Phone book** to select contact
- Press **Send**

### 5.3 Delete SMS

- Press the **MENU** key
- Select **Messages** and press **OK**
- Select **Inbox** and press **OK**
- Select message from the list and press **Read**
- Press **Options** select **Delete** and press **OK**

## 5.4 Message Settings

### Message Center

- Press the **MENU** key
- Select **Messages** and press **OK**
- Select **Message settings** and press **OK**
- Select **Service center** by and press **OK**
- Enter the number that your service provider gave you and press **OK**

*Note: If the number is already entered, press **OK**.*

### Message Lifetime

- Press the **MENU** key
- Select **Messages** and press **OK**
- Select **Message settings** and press **OK**
- Select **Validity period** and press **OK**
- Using arrow keys ▲ ▼ select preferred message lifetime and press **OK**

*Note: Message lifetime is the amount of time that an unread message will remain on the network server before being removed.*

## 6 ADDITIONAL FEATURES

### 6.1 Date and Time Settings

#### Set the time

- Press the **MENU** key
- Select **Settings** and press **OK**
- Select **Time and date** and press **OK**
- Select **Adjust time** and press **OK**
- Set time by using number keypad or arrow keys ▲ ▼ and press **OK**

#### Change the time format

- Press the **MENU** key
- Select **Settings** and press **OK**
- Select **Time and date** and press **OK**
- Select **Time format**, select preferred time format and press **OK**

#### Set the date

- Press the **MENU** key
- Select **Settings** and press **OK**
- Select **Time and date** and press **OK**
- Select **Adjust date** and press **OK**
- Set date by using number keypad or arrow keys ▲ ▼ and press **OK**

**Change the date format**

- Press the **MENU** key
- Select **Settings** and press **OK**
- Select **Time and date** and press **OK**
- Select **Date settings** and press **OK**
- Select **Date format**, select date format by using arrow keys ▲ ▼ and press **OK**

**Turn date display on the LCD screen On/Off**

- Press the **MENU** key
- Select **Settings** and press **OK**
- Select **Time and date** and press **OK**
- Select **Date settings** and press **OK**
- Select **Show date**, select **ON** or **Off** and press **OK**

**6.2 Address Book**

GSM desktop phone stores all contacts in the SIM card. Depending on the SIM card (SIM cards may have different memory capacities) phonebook is capable of storing up to 240 phone numbers with names.

*Note: To dial a number from the phonebook pick up the handset and press **Phone book**.*

**Add new contact**

- Press the **MENU** key
- Select **Contacts** and press **OK**
- Select **New contact** and press **OK**
- Enter name the by using number keypad and press **OK**
- Enter the number by using number keypad and press **OK**

*Note: To input the “+” character press and hold “0” key.*

**Edit contact in the phone book**

- Press the **NAMES** key
- Select contact by using arrow keys ▲ ▼ and press **OK**
- Press **Options**, then select **Edit contact** and press **OK**
- Edit the name and press **OK** then edit the number and press **OK**

**Delete contact**

- Press the **NAMES** key
- Select contact by using arrow keys ▲ ▼ and press **OK**
- Press **Options**, then select **Delete** by and press **OK**

### 6.3 Speed Dialing

Speed dialing function allows to quickly selecting saved number by using a number keypad keys (1-9). To program number keypad keys please do the following:

- Press the **MENU** key
- Select **Contacts** and press **OK**
- Select **Speed dial** and press **OK**
- Select wanted keypad number and press **Options**
- Select **Edit number** press **OK**
- Enter the number and press **OK**

### 6.4 Audio Settings

#### Increase/Decrease ring volume

- Press the **MENU** key
- Select **Settings** and press **OK**
- Select **Sound** and press **OK**
- Select **Ring volume** and press **OK**
- Change ring volume by using arrow keys ▲ ▼ and press **OK**

#### Change ring tone

- Press the **MENU** key
- Select **Settings** and press **OK**
- Select **Sound** and press **OK**
- Select **Ring tone** and press **OK**
- Select preferred ring tone by using arrow keys ▲ ▼ and press **OK**

#### Increase/Decrease message volume

- Press the **MENU** key
- Select **Settings** and press **OK**
- Select **Sound** and press **OK**
- Select **Message volume** and press **OK**
- Change message volume by using arrow keys ▲ ▼ and press **OK**

#### Select message tone

- Press the **MENU** key
- Select **Settings** and press **OK**
- Select **Sound** and press **OK**
- Select **Message tone** and press **OK**
- Select preferred melody tone by using arrow keys ▲ ▼ and press **OK**

#### Increase/Decrease speech volume

- Press the **MENU** key
- Select **Settings** and press **OK**

- Select **Sound** and press **OK**
- Select **Speech volume** and press **OK**
- Change speech volume using arrow keys ▲ ▼ and press **OK**

### Turn On/Off phone keypad tone

- Press the **MENU** key
- Select **Settings** and press **OK**
- Select **Sound** and press **OK**
- Select **Key tone** and press **OK**
- Using arrow keys ▲ ▼ select **On** or **Off** and press **OK**

## 6.5 Alarm

The alarm feature can be used as an alarm clock. Alarm time and tone can be set for daily use or for one time only

### Set alarm time

- Press the **MENU** key
- Select **Settings** and press **OK**
- Select **Time and date** and press **OK**
- Select **Alarm** and press **OK**
- Select **Alarm time** and press **OK**, then select **On** and press **OK**
- Set time using number keypad or by using arrow keys ▲ ▼ and press **OK**
- Choose repeat alarm or not (**On** or **Off**) and press **OK**
- If repeat- select days to by repeat alarm using arrow keys ▲ ▼ and pressing **Change**. When finished press **OK**.

### Set alarm volume

- Press the **MENU** key
- Select **Settings** and press **OK**
- Select **Time and date** and press **OK**
- Select **Alarm** and press **OK**
- Select **Alarm options** and press **OK**
- Select **Alarm volume** and press **OK**
- Change alarm volume by using arrow keys ▲ ▼ and press **OK**

### Set alarm tone

- Press the **MENU** key
- Select **Settings** and press **OK**
- Select **Time and date** and press **OK**
- Select **Alarm** and press **OK**
- Select **Alarm options** and press **OK**
- Select **Alarm tone** and press **OK**
- Select preferred alarm melody by using arrow keys ▲ ▼ and press **OK**

## 6.6 Language Selection

To select the language use following instructions:

- Press the **MENU** key
- Select **Settings** and press **OK**
- Select **Language** and press **OK**
- Select preferred language by using arrow keys ▲ ▼ and press **OK**

## 6.7 Dial delay

Dial delay is the amount of time, for the phone before automatically making a call after dial number is entered. To set the time use following instructions:

- Press the **MENU** key
- Select **Settings** and press **OK**
- Select **Call services** and press **OK**
- Select **Dial delay** and press **OK**
- Select delay time by using arrow keys ▲ ▼ and press **OK**

## 6.8 Baby call

Baby call feature allows automatic calling after handset is picked up. The time and number are programmed. Use following instructions to enable this feature:

- Press the **MENU** key
- Select **Settings** and press **OK**
- Select **Call services** and press **OK**
- Select **Baby call** and press **OK**
- Select **Baby call delay** and press **OK**
- Select delay time and press **OK**
- Select **Baby call number** and press **OK**
- Enter the phone number or use a **Phone book** to select contact

*Note: to disable Baby call feature select **Disable** in **Baby call delay** menu.*

## 6.9 Security settings

### Change PIN code

- Press the **MENU** key
- Select **Settings** and press **OK**
- Select **Security** and press **OK**
- Select **Change PIN code** and press **OK**
- Enter PIN code and press **OK**
- Enter new PIN code and press **OK**

*Note: to change PIN code PIN code request must be enabled.*



**Pin code request**

- Press the **MENU** key
- Select **Settings** and press **OK**
- Select **Security** and press **OK**
- Select **PIN code request** and press **OK**
- Enter PIN code and press **OK**
- Use arrow keys ▲ ▼ to turn **On** or **Off** PIN code request and press **OK**

**Show IMEI number**

- Press the **MENU** key
- Select **Settings** and press **OK**
- Select **Misc** and press **OK**
- Select **Show IMEI** and press **OK**

**Show software version**

- Press the **MENU** key
- Select **Settings** and press **OK**
- Select **Misc** and press **OK**
- Select **Show software version** and press **OK**

**6.10 Restore Factory Defaults**

- Press the **MENU** key
- Select **Settings** and press **OK**
- Select **Factory reset** and press **OK**
- Confirm resetting device to factory defaults by pressing **OK**

**7 SUPPLEMENTARY SERVICES (NETWORK DEPENDENT)****7.1 Call Forwarding**

Call forwarding feature allows redirecting incoming calls to another telephone number, even when the device is turned off.

Call forwarding options include:

**All** - all calls

**If busy** - calls that come in when the line is busy

**No answer** - calls that are not answered after a specified number of seconds

**Not reachable** - calls that come in when DPH200 is not reachable (no signal or turned off).

**Turn On/Off call forwarding feature**

- Press the **MENU** key
- Select **Settings** and press **OK**
- Select **Call services** and press **OK**
- Select **Call forwarding** and press **OK**
- Select the desired forwarding type and press **OK**

- Using arrow keys ▲ ▼ select **Enable or Disable** and press **OK**
- Enter the phone number or use a **Phone book** to select contact

### Cancel all call forwarding

- Press the **MENU** key
- Select **Settings** and press **OK**
- Select **Call services** and press **OK**
- Select **Call forwarding** and press **OK**
- Select **All**, then select **Disable** and press **OK**

## 7.2 Call Barring

Call barring feature allows barring of incoming or outgoing calls. The following calls barring options are available:

**All outgoing** - do not allow any calls to be made.

**Outgoing international** - do not allow international calls.

**Int. ex. to home country** - do not allow international calls except to home country.

**All incoming** - do not allow any incoming calls.

**Incoming when roaming** - do not allow any incoming calls if rooming

**Disable all** - do not allow any calls to be made or received.

### Turn On/Off call barring feature

- Press the **MENU** key
- Select **Settings** and press **OK**
- Select **Call services** and press **OK**
- Select **Call barring** and press **OK**
- Select the desired barring type
- Using arrow keys ▲ ▼ select **Enable/Disable** and press **OK**

## 7.3 Call Waiting

Call Waiting enables notification of incoming calls when the DPH200 is on call. To respond to Call Waiting, press **Answer** to answer or **Reject** to reject the call. Press **Options** then **Hold** to switch between incoming calls. Contact your service provider to activate Call Waiting feature.

### Turn On/Off call waiting feature

- Press the **MENU** key
- Select **Settings** and press **OK**
- Select **Call services** and press **OK**
- Select **Call waiting** and press **OK**
- Using arrow keys ▲ ▼ select **Enable/Disable** and press **OK**

## 7.4 Call Transfer

A call transfer feature allows transferring an existing call to another phone. Contact your service provider to activate Call Waiting feature.

### Call transfer

- During call press **Hold**,
- Press **Options**
- Select **New call** and press **OK**
- Enter the phone number and press **DIAL** key or use a **Phone book** to select contact and press **Call**.
- Press **Options**, select **Transfer** and press **OK**

*Note: to use a speed dialing press and hold the key for 2s.*

*Note: to switch between calling numbers press **Options** then press **Hold**.*

## 8 TECHNICAL SPECIFICATIONS

### **GSM Interface**

Quad-Band GSM 850 / 900 / 1800 / 1900 MHz.

Output power:

class 4 (2 W) for EGSM 850/900.

class 1 (1 W) for GSM 1800/1900.

### **Memory**

Address book up to 240 entries (SIM dependant)

SMS memory up to 30 (SIM dependant)

Call memory: 10 last dialed, 10 last received, 10 last missed

### **Power supply**

Mains adaptor: 100 - 240 V AC / 5.2V  1A

Built in lightning protection

Battery: NiMH 3.6V 1600 mAh

Power consumption when talking 2W (peak)

Power Consumption stand by (100mW)

Battery charging time 10 hours

Standby time: 120 hours

### **Temperature & humidity**

Operation 0<sup>0</sup> to 55<sup>0</sup> C

Storage temperature -20<sup>0</sup> to 80<sup>0</sup> C

Humidity 10% to 90%

Storage humidity 5% to 95%

### **Dimensions / weight**

Approx. 220 x 170 x 65 mm

Weight: Approx. 920 g

### **Other**

External omni directional antenna (SMA)

Antenna Gain 2dBi

Port for FW update - RJ45 (UART)

## 9 TROUBLESHOOTING

Messages	Description	Solution
No network	1. Antenna not connected 2. No network signal or signal level too low	1. Connect antenna and wait until network is found 2. Contact your GSM network operator
Error	General error message	Contact your GSM network operator if message persists
Network timeout	Request failed to execute	Contact your GSM network operator if message persists
Error sending	Error occurred while sending SMS	1. Check Service center number under Message settings. 2. Contact your GSM network operator
Wrong format	Format of received SMS is not supported	
SIM not inserted	SIM card is not inserted	Turn device Off, insert SIM card and turn device On
SIM failure	SIM card is corrupted or missing	Turn device Off, insert valid SIM card and turn device On
SIM busy	SIM card is busy	1. Wait for SIM card to become available 2. Insert valid SIM card 3. Contact your GSM network operator
SIM wrong	Wrong SIM card is inserted	Turn device Off, insert valid SIM card and turn device On
Enter PIN	PIN code is required	1. Enter correct PIN code 2. Contact your GSM network operator
Enter PIN2	PIN2 code is required	1. Enter correct PIN2 code 2. Contact your GSM network operator
Enter PUK	PUK code is required	1. Enter correct PUK code 2. Contact your GSM network operator
Enter PUK2	PUK2 code is required	1. Enter correct PUK2 code 2. Contact your GSM network operator
Service not available	Service requested is not available	Contact your GSM network operator for available services
Service not subscribed	Service requested is not subscribed	Contact your GSM network operator for available services
Service code error	Error occurred while executing service request	Contact your GSM network operator for available services
Phone book error	Error occurred during initialization of Phone book	Replace SIM card if error persists
Inbox error	Error occurred during initialization SMS inbox	Replace SIM card if error persists
Inbox full	SMS inbox is full	Delete some/all messages to be able to receive new SMS messages